

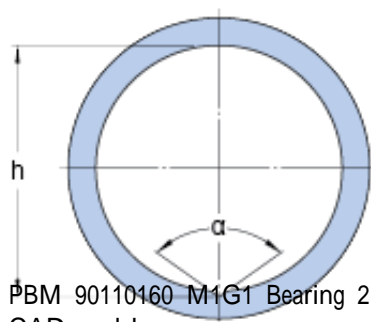

BEARING INDUSTRIA CUSCINETTI S.P.A.

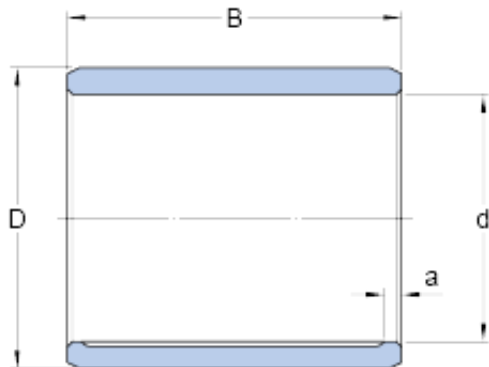

PBM 90110160 M1G1 Bearing 2D drawings and 3D CAD models

90 mm x 110 mm x 160 mm skf PBM 90110160
M1G1 Plain bearings, Bushings

Bearing No. PBM 90110160 M1G1

d	90 mm
D	110 mm
B	160 mm
a	8 mm
h	91.5 mm
	124 °
Tolerance shaft	e7
Tolerance housing	H7
Specific dynamic load factor K	25 N/mm ²
Specific static load factor K ₀	45 N/mm ²
Permissible sliding velocity v min.	0 m/s
Permissible sliding velocity v max.	0.5 m/s
Coefficient of friction μ min.	0.08
Coefficient of friction μ max.	0.15
Mass bushing	4.45 kg