

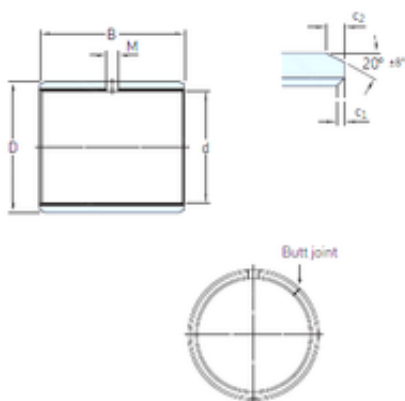

BEARING INDUSTRIA CUSCINETTI S.P.A.



4,763 mm x 6,35 mm x 4,763 mm skf PCZ 0303
E Plain bearings, Bushings

Bearing No. PCZ 0303 E

Size	4.763x6.35x4.763 mm
Bore Diameter	4,763 mm
Outer Diameter	6,35 mm
Width	4,763 mm
d	4,763 mm
D	6,35 mm
B	4,763 mm
c1 min	0,1 mm
c2 min	0,2 mm
M	– mm
Weight	0,00048 Kg
Basic dynamic load rating (C)	1,8 kN
c ₁ min.	0.1 mm
c ₁ max.	0.4 mm
c ₂ min.	0.2 mm
c ₂ max.	0.8 mm
± 8	20 °
Shaft diameter range min.	4.719 mm
Shaft diameter range max.	4.737 mm
Housing bore range min.	6.342 mm
Housing bore range max.	6.358 mm
Basic dynamic load rating - radial direction C	1.8 kN
Basic static load rating - radial direction C ₀	5.7 kN

PCZ 0303 E Bearing 2D drawings and 3D CAD models



BEARING INDUSTRIA CUSCINETTI S.P.A.

Specific dynamic load factor K	80 N/mm ²
Specific static load factor K ₀	250 N/mm ²
Factor depending on material and bearing type K _M	480
Permissible sliding velocity v min.	0 m/s
Permissible sliding velocity v max.	2 m/s
Coefficient of friction μ min.	0.03
Coefficient of friction μ max.	0.25
Mass bushing	0.00048 kg